

Supreme Quality Dishwasher

**DolPhin**

# DISHWASHER USER MANUAL

“Toward the best customer service”

Dolphin promises world's best customer service.



## MODEL DW-3200 Series

DW-3200i / DW-3200S / DW-3200ie / DW-3200Se

### Contents

Dishwasher Features 02\_03 | Notice on Operation 04\_05  
Prevent electrical leakage and shock 06 | Precautions 07 | Part Name 08  
Display on operating 09 | Check points before operating 10  
Tip for dishwashing and M/C cleaning 11 | Dimension & Specification 12\_13  
A/S information 14 | Trouble shooting 15

**DolPhin** 

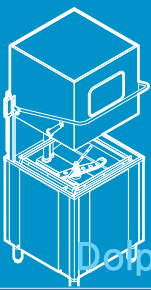

# HOOD TYPE DISHWASHER

Dolphin Automatic Dishwasher >>

## “BEST SOLUTION FOR YOUR KITCHEN”

### | Dishwasher Features



#### JET-BEAM WASH ARM

3D jet-beam spray nozzle is designed for the optimal spray angle and actualizes strong washing efficiency like waterfall shower.

Patented 30-0380197



#### BUILT-IN DISPENSER

Dolphin provides built-in dispenser of detergent and rinse aid for all models which is automatically controlled at each stage by MICOM.



#### BUILT-IN BOOSTER

Built-in booster tank provide the effective heat saving and practical space usage. And booster tank reduces operating costs by reducing heat loss.

The heat-conduction between booster and wash tank maximizes energy efficiency (for 3000 & 5000 series).



### **SUPER(S-TYPE) WASH ARM**

The Dolphin new technology, fixed wash arm makes dishes clean from detergent residual.

The vane of full cone nozzle and the square washing zone enables water spray to eliminate the blind spot.

Patented 10-0626274



### **ENERGY SAVING DEVICE (Option)**

E/S device recovers the waste heat from drain water by heat-conduction. It improves washing capacity by reducing the energy consumption, heating time.

Patented 10-0462171



### **REMOTE CONTROLLER**

Remote controller is not interrupted by installed position even in corner installation. User can read operating stage and upcoming process through FND easily.

You can set each cycle by sec. and check total running number. The test mode programmed can diagnosis working status of each part on the controller.

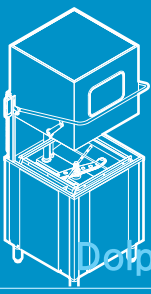

# HOOD TYPE DISHWASHER

Dolphin Automatic Dishwasher >>

## Notice on Operation

- Never wash the vessels with poisons that can be dangerous if contaminated to the dishes

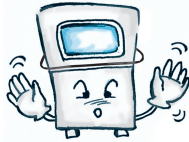

- Never put an inflammable liquid into the machine that can be the cause of explosive accident



- Never open the door while operating that might be dangerous to get burned by hot water



- Keep the door closed while operating, otherwise dangerous to get burned by hot water

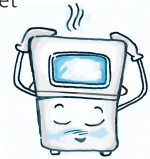

- Call service center if any problem. Only an authorized technician is possible for maintenance



- Ground the wire. Otherwise, electric shock and leakage may occur



- Do not place anything top of dishwasher that may cause machine trouble



- Do not pour the water to the machine that can cause of electrical leakage while cleaning M/C



- Install the machine in a well-ventilated & no flammable agent



- If a gas booster ignition error occurs, contact a service center immediately. Make sure to close gas valve and check gas leakage



- Use only low forming detergent for dishwasher. High foaming soaps can interfere with good washing



- Keep chemical agents away from children



- Do not get the detergent in skin, clothes and eyes when exchanging chemicals. Detergents are highly corrosive to skin, eyes and clothing.



- Do not inducing vomiting if drink detergent. Instead, give two glasses of water and then, immediately go to see a doctor



- Wear physically & chemically impervious gloves and apron while cleaning and moving machine. Otherwise, get an injury during cleaning and moving



- Avoid the materials; reactive with acids and alkalis etc



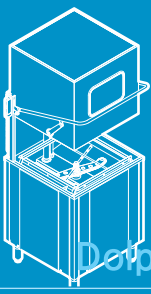

# HOOD TYPE DISHWASHER

Dolphin Automatic Dishwasher >>

## Prevent electrical leakage and shock

If the machine is not grounded, please call to service center

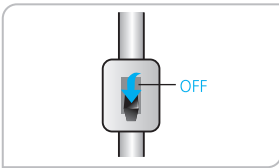

Equip earth leakage breaker and make sure to ground the wire to avoid an electrical accident

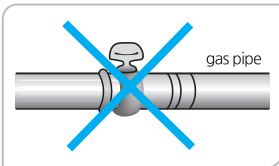

Never ground to a gas pipe  
- Never connect explosive materials

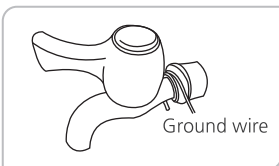

Connect the wire to metal pipe [no PVC pipe]

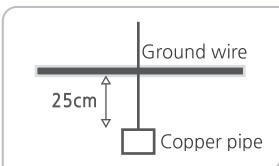

Connect the wire to Copper pipe  
- Copper pipe should be installed with 25cm deep

## Precautions

When using the washing machine, be sure to read the precautions for minimal malfunction and accident

### Winter season and storage maintenance

- Drain water completely for freezing prevention.
- Drain water completely for long-term storage  
When operate again, call service center
- During periods of non-use, turn off circuit breaker

### Caution in underground water

- If hard water is supplied to the machine, it may cause part defects of heater or pump by lime scale.  
Be sure to install water softener.  
(The damage caused by hard water is not covered by warranty)

### Important

- When gas leakage is detected, shut down the main gas and contact the local gas company or gas supplier for the service

### For your safety

- Do not store gasoline and any other flammable vapors or liquids nearby the machine

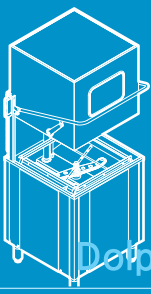

# HOOD TYPE DISHWASHER

Dolphin Automatic Dishwasher >>

## Part Name

High quality & durable parts in  
**AISI 304 Stainless Steel** body

1. Door handle
2. Window
3. Rinse arm
4. Wash arm
5. Strainer
6. Display & Control

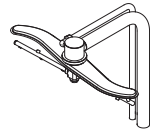
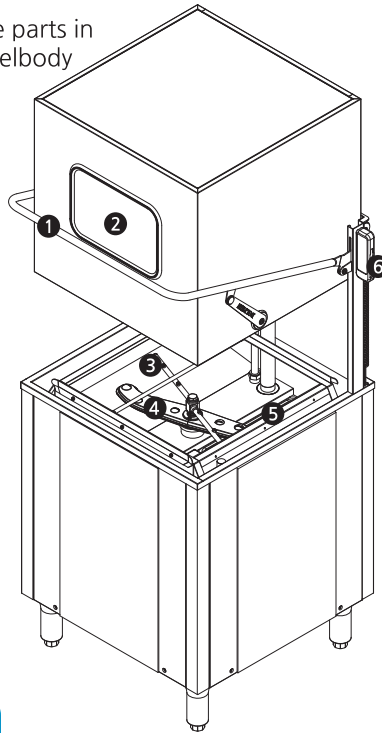

DW-3200i  
Rotary wash arm

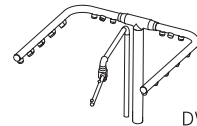

DW-3200S  
Fixed wash arm

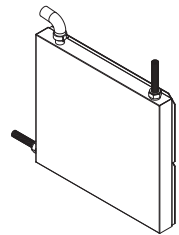

E/S device  
DW-3200ie / DW-3200Se

## Basic Components

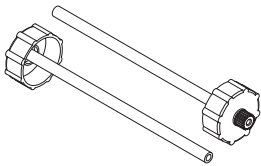

Chemical Caps

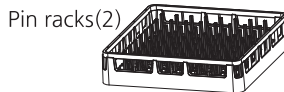

Pin racks(2)



Flat racks(1)



Instruction Manual



## Display on operating

“Easy to use at both sides of Machine”

Available to hang on left or right hand of dishwasher



### Usage of Dishwasher

- Water : watering to wash tank
- Ready : ready to operate [heating & detergent]
- Stand by : preparation for operation
- Wash : wash dishes
- Rinse : rinse dishes
- Detergent : feeding the detergent
- Rinse aid : feeding the rinse aid
- Finish



- Power ON/Off

Power



- ready to operate/lock the M/C

Ready

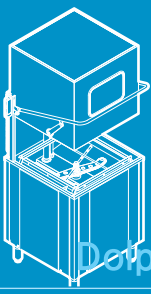

# HOOD TYPE DISHWASHER

Dolphin Automatic Dishwasher >>

## Check points before operating

1. Place drain pipe and strainer on right place
2. Check booster tank drain valve closed
3. Check the electricity, water and gas

### 1. In case of using gas booster, open valve of gas booster

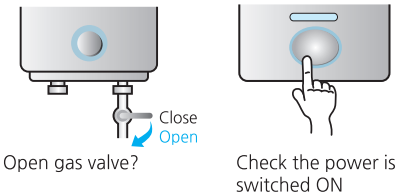

### 2. Turn on the main switch

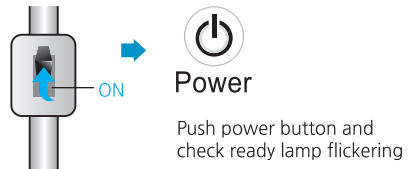

### 3. Controller

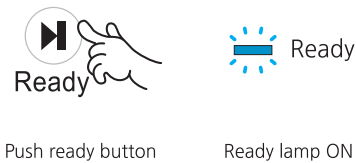

### 4. Await for watering after closing the door

After watering and supplying chemicals, M/C get to standby



### 5. Wash

- A. Put the dishes into the rack
- B. Put the lack into the machine
- C. Close the door. The machine will be automatically operated by door actuation system

### 6. Rinse the dishes and Rinse aid feeding

After finish up the wash course, automatically operate as programmed

### 7. Finish

Buzz for the finish and finish & stand by lamp on

## Tip for dishwashing and M/C cleaning

Proper use and care of the washing M/C can extend the life of washing M/C

### Tip for washing

- Scrap the dishes to remove large particles of food and debris [prewash]

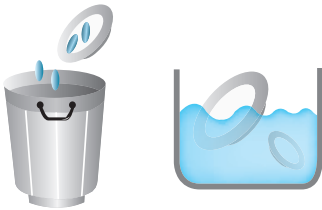

- Arrange the dishes in the rack. Don't stack dishes one on top of another as water must have free access to all sides of every dish

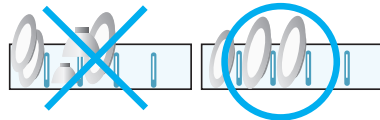

- After filling a rack, open the door, slide a rack into the dishwasher and close the door

### Tip for cleaning dishwasher

#### 1. Cautions for dishwasher

- The machine must be thoroughly cleaned at the end of each working shift or at least daily
- Never use steel wool to clean the dishwasher

#### 2. Cleaning

- Turn off the power button
- Drain wash water by taking out drain pipe and strainer
- Clean off the strainer
- Clean and flush the dishwasher inside and remove a remained soil with soft cloth or brush
- Replace all removed parts and leave the machine door open to allow inside to air out and dry

※ Safety gloves must be worn when cleaning the inside/outside of the machine, as if may cause injury

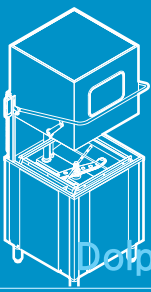

# HOOD TYPE DISHWASHER

Dolphin Automatic Dishwasher >>

## Dimension & Specification

### Dimension

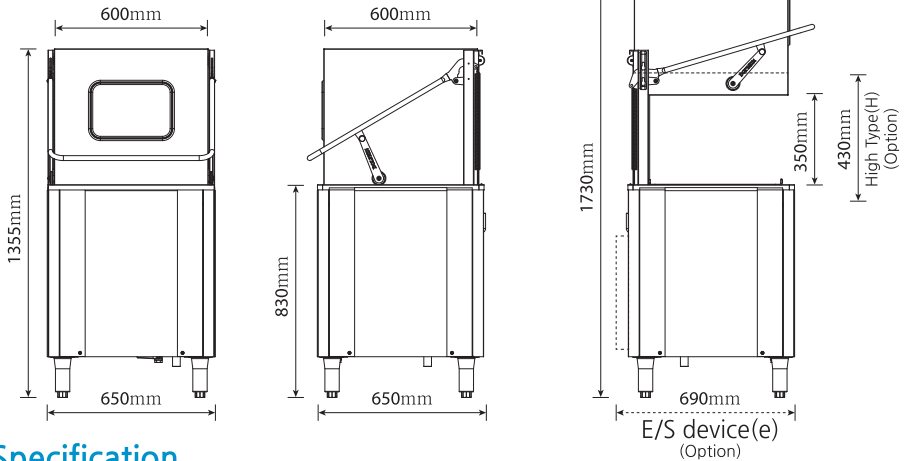

### Specification

Item	Spec	Item	Spec
● Model	DW-3200 Series	● Type	Hood TYPE
● Wash Tank	40ℓ	● Dimension	650(W)×650(D)×1355(H)mm 650(W)×725(D)×1425(H)mm(Option)
● Wash Temp	60 ~ 65℃	● Wash Time	40 Sec ~ 120 Sec (8 Steps)
● Rinse Tank	25ℓ	● Rinse Time	6 Sec ~ 13 Sec (8 Steps)
● Rinse Temp	80 ~ 85℃	● Detergent	Low foaming Dishwash Detergent
● Max Consumption power	4.0 ~ 13.2kW	● Wash Capacity (hour)	51~60 Racks per hour
● Used Voltage	1PH 220V 50/60Hz 3PH 380V 50/60Hz		

## Available models of DW-3000series

MODEL	i Type	S Type	e (Option)	Heater
● DW-3210	<input type="radio"/>	<input type="radio"/>	<input type="radio"/>	2.8 kW
	<input type="radio"/>	<input type="radio"/>	<input type="radio"/>	4.0 kW
	<input type="radio"/>	<input type="radio"/>	<input type="radio"/>	8.0 kW
● DW-3280	<input type="radio"/>	<input type="radio"/>	<input type="radio"/>	

## Option Spec

### (e)ENERGY SAVING DEVICE (Option)

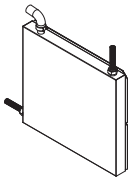

E/S device recovers the waste heat from drain water by heat-conduction. It makes washing capacity improving by reducing the energy consumption, heating time.

Patented 10-0462171

DW-3200ie

(i) + (e)

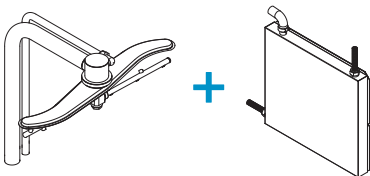

DW-3200Se

(s) + (e)

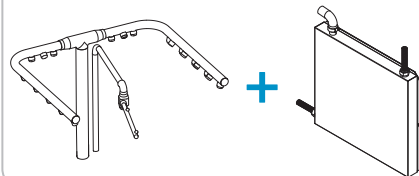

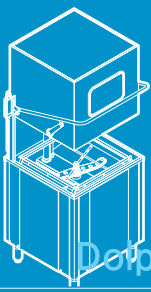

# HOOD TYPE DISHWASHER

Dolphin Automatic Dishwasher >>

## A/S information



- Before A/S request, please check trouble shooting and follow out instruction.

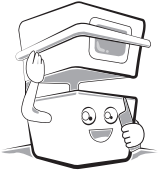







- Please ask Dolphin agent for purchasing of dishwasher, accessory and chemicals

- Contact information



# Trouble shooting

Before service call, check the symptoms and related causes

Symptom	Possible cause	Solution
<p>● Higher forming than usual</p> 	Do not use dishwasher detergent?	Use dishwasher detergent
	Low temperature of wash water?	Check wash water temperature
<p>● No ignition of gas booster</p> 	Closed gas valve?	Open valve
	Closed water valve?	Open valve
	Battery out for ignition?	Exchange batteries
	Dripped water by low pressure?	Close another valve
<p>● Gas booster kept on</p> 	Take out the drain pipe?	Put it on wash tank
	Close booster tank(ball) valve?	Close booster tank(ball) valve.
<p>● Wash defects</p> 	Debris on the nozzles of wash arm?	Remove debris
	Runout of detergent?	Refill up a detergent
<p>● Dry defects</p> 	No rinse aid?	Refill up a rinse aid
	Low temperature of rinse water?	Use the M/C at the proper temperature
	Debris on nozzle of rinse arm?	Remove debris
<p>● Weak wash blade or drip</p> 	Food or debris on the filter of wash pump	Remove debris



\* The specification is subject to change without notice for improvement and the color could be different from real product.



**DOLPHIN CO.,LTD**

32, 229 Rd., Oksan-Str., Bucheon-Si, Gyeonggi-Do, 14519 Korea

**TEL. 82-32-612-3456 FAX. 82-32-682-3814**